











33 800 861



- Ausladung 200 mm
- schwenkbarer Auslauf 360°
- optional schwenkbegrenzbar mit Schwenkbegrenzungsset 12 820 970 90
- luftangereicherter Strahl
- Durchfluss max. 8 l/min bei 3 bar Fließdruck
- bleifrei
- Dieses Produkt leistet einen Beitrag zur Erfüllung der Vorgaben von nachhaltigen Gebäudezertifizierungen, z.B. LEED®, BREEAM®, DGNB

	Chrom	33 800 861-00
	Platin gebürstet	33 800 861-06
	Platin	33 800 861-08
	Messing (23kt Gold)	33 800 861-09
	Dark Chrome	33 800 861-19
	Messing gebürstet (23kt Gold)	33 800 861-28
	Schwarz matt	33 800 861-33
	Champagne gebürstet (22kt Gold)	33 800 861-46
	Champagne (22kt Gold)	33 800 861-47
	Chrom gebürstet (Edelstahl-Look)	33 800 861-93
	Dark Platinum gebürstet	33 800 861-99

**Empfohlenes Zubehör**

**Schwenkbegrenzungsset - 12 820 970 90**



**Empfohlenes Zubehör**

**Exzenterbetätigung mit Drehknopf - Chrom 10 712 970-00**



**Empfohlenes Zubehör**

**Spender ohne Rosette - Chrom 82 424 970-00**



33 800 861

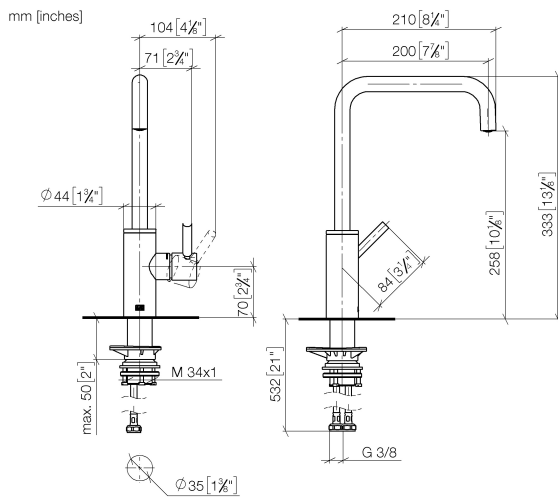

### Durchflussdiagramm



### Zertifikate

LGA\_38642.

WRAS\_240102021.

33 800 861

